



Owner's Manual

WATER-PRO SERIES

MODULAR B-60 12/24V DC

Version: 170221

Reference: 45106003

Eco-Sistems Watermakers, S.L.

Oficina: C/ Horta nº 22 – Almacén: C/ Gran Vía Puig i Cadafalch nº 233

(08203)- Sabadell – Barcelona (Spain)

Tel: 34.93.710.89.50 – Fax: 34.93.712.23.55

E-mail: info@eco-sistems.com

Web: www.eco-sistems.com

WATER-PRO MODULAR B-60 12/24V DC

MEMBRANE VESSEL
60 LITRES



2-HOSE H.P.

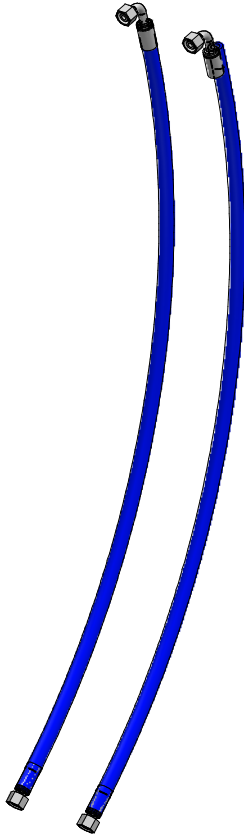

TUBE Ø6X4 BLUE



TUBE Ø8X6 BLUE

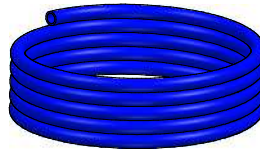

HOSE 1/2 BLUE



HOSE CLEAR BRAID Ø20



PANEL CONTROL SET

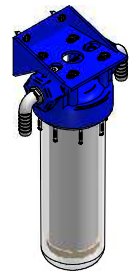

FWF FILTER SET

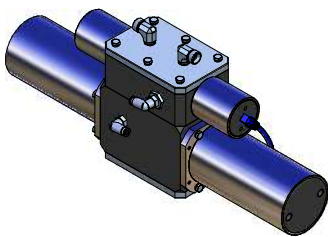

ST-15 CERAMIC
ECO-SYSTEMS PUMP



CONNECTOR Ø8 TUBE X
1/4 BSP PLASTIC

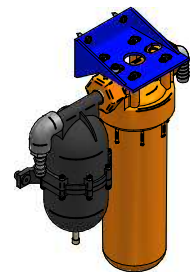

LOW PRESSURE FILTER SET



2-ADAPTER 1/2 BSP X
1/2 BARB PVC



ADAPTER 1/2 BSP X
3/4 BARB PVC

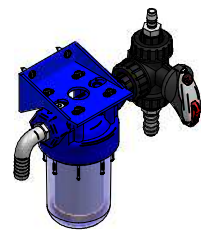

SEA STRAINER SET

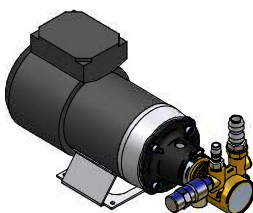

MOTOR PUMP
12/24 V DC SET



4 - HOSE CLAMP Ø16/27



10 -HOSE CLAMP Ø12/22



FILTER WRENCH

TABLE OF CONTENTS

CHAPTER I:

- **Installation, operation and maintenance.**

CHAPTER II:

- **Storage and Cleaning.**

CHAPTER III:

- **Drawings, description and exploded views
ST-15/CERAMIC Eco-sistems Pump**

CHAPTER IV:

- **Filter and Membrane Replacement.**

CHAPTER V:

- **Warranty and identification sheet.**
- **Dealers and After-Sale Service List.**

CHAPTER I

**INTALLATION, OPERATION
AND MAINTENANCE**

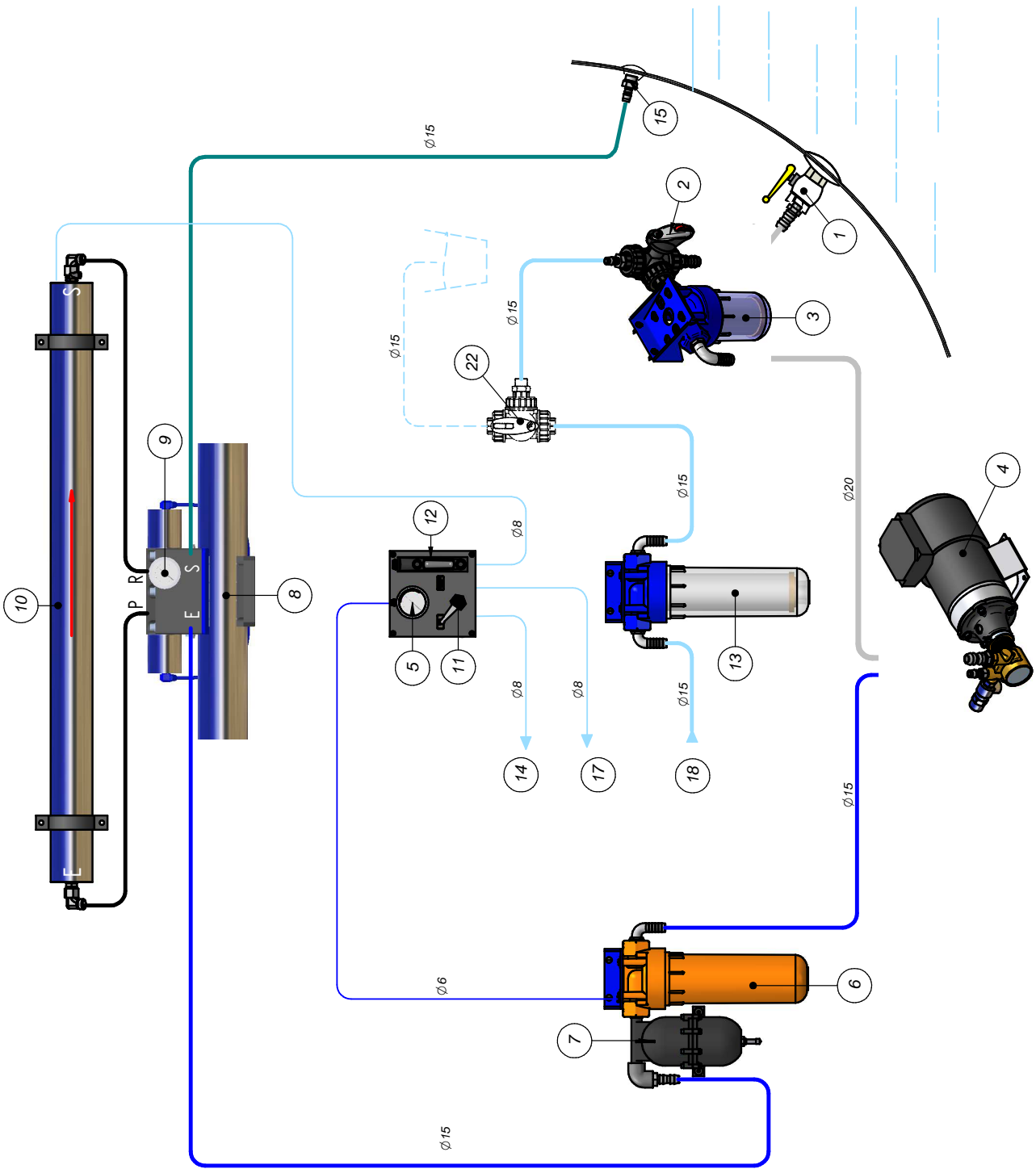

WATER-PRO MODULAR B-60 12/24V DC

SYSTEM COMPONENTS

1. - Seacock valve to uptake the sea water.
2. - PRODUCTION/FLUSHING Three Way Valve.
3. - Protection pre-filter. (Washable mesh filter).
4. - Low pressure booster pump. 12/24V DC motor.
5. - Low Pressure Gauge.
6. - 5 microns filter container.
7. - Expansion Vessel.
8. – ST-15/CERAMIC High pressure pump with energy saving system. Energy recovering.
9. - High Pressure Gauge.
10. - R.O. Membrane and Vessel.
11. -Three ways valve for the produced water.
12. - Produced Water Flow meter.
13. - Anti Cl carbon filter.
14. - Produced water output to the tank.
15. - Brine discharge thru-hull
17. - Direct produced water output. (CONTROL)
18. – Boat fresh water input
22. – (OPTIONAL) Three way valve for wintering.

I.1. Installation. (See diagram Chapter I Pages 1 and 2)

For the installation of the system, it must be taken into account that the pump can reach a temperature up to 55°C, so it must be placed in such a way that it does not affect the surrounding elements. Furthermore, to assemble the unit you will need to have the following inlet and outlet connections ready:

- Seacock (1) with a minimum nominal pitch of 3/4" Gas responsible for water intake, which should be located as low as possible on the bottom of the hull in order to prevent possible cavitation problems due to air aspiration.
- 1/2" Gas female thread through-hull (15) fitting for connecting the internal blue tube Ø12 that drains the rejected water into the sea.
- 1/4" Gas female thread inlet in the main tank for the intake of the fresh water produced.
- 1/2" Gas female inlet for pressurised intake of water used on the watermaker's cleaning process.

WARNING

It is very important to place the sea strainer (3) as close as possible to the motor pump (4), making shure both of them are located below the waterline, lastly, check that at least a minimum flow of 10 liters/minute is supplied to the motor pump (4), to prevent it from cavitations due to a pressure fall.

The other components belonging to the unit can be located at a higher level, provided that they do not exceed a distance of 4 or 5 metres and taking into account that the membrane (10) and the high pressure pump (8) must be connected by the 1 meter long high pressure tubes. In longer distances, pressure drop increases significantly, increasing the power consumption.

The membrane's building position is irrelevant (vertical/horizontal), but in case of placing it in a vertical position, the outlet fresh water tube has to be on the upper part.

The membrane is normally delivered assembled inside the high-pressure container. If it has not been factory-installed look for the assembling information in Chapter IV.

After all components have been put in place and fixed, the unit will be ready for hydraulic and electrical connection, which will be covered in the following sections.

I.2. Hydraulic connections.

The connection between the various components is made with the tubes supplied with the unit, as shown in the diagram in Chapter I Pages 1 and 2.

The two suction connections between the points described below are made using the transparent tube Ø20

- Lower three way valve inlet (2) and sea cock valve seawater intake (1).
- Sea strainer outlet (3) and pump inlet (4).

The connection between the boat pressurized water intake to the carbon filter inlet (13) and the connections between the carbon filter outlet and the three way valve inlet (2), have to be made with the Ø15 blue tube

As a general rule, the tube sections should be as short and as straight as possible to avoid unnecessary pressure drop, and the connections should be completely airtight so that air does not enter the circuit during water suction.

The remaining seawater circuit sections are made with blue tube Ø15 (maximum pressure 20 bar) **It is a special tube developed to work with up to 20 bar, and it is not recommended to be replaced with a different one (even of similar characteristics)**

To make the connections proceed as indicated below:

- Pump outlet (4) and 5-micron pre-filter inlet (6).
- Pre-filter outlet (6) and the high-pressure pump (8) inlet elbow (E).
- Outlet elbow (S) of the pressure amplifier pump (8) and the brine outlet (15).

The referred elbows marked as E and S are located in the back / lower part of the high pressure pump (8)

To connect the high pressure pump (ETD) with the R.O. membrane vessel proceed to use a high pressure hose (blue with stainless steel terminals) from the stainless steel connection located in the brine outlet, marked with the letter (P) in the back side of the high pressure pump (8), with the stainless steel elbow located in the R.O. membrane vessel, marked as ENTRADA (E) Then proceed to connect link the R.O. membrane vessel elbow marked as SALIDA (S) to the stainless steel adaptor marked as (R) located at the high pressure pump(8).by using the other high pressure hose(blue with stainless steel connections).

By using the Ø8 polyamide tube, connect the end cap plastic adaptor (10), located in the membrane vessel inlet with the lower flow meter connector (12) as well as with the three way valve outlets (11), connect the left adaptor to the main tank adaptor (14), and the right adaptor to the produced fresh water outlet (17).

I.3. Hidraulic Control Panel.

The control panel shown in the diagram in Chapter I on Page 1 is made up of a flow meter (12) indicating the production of freshwater, a low-pressure pressure gauge (5) and a three-way valve (11), which should be connected up as follows:

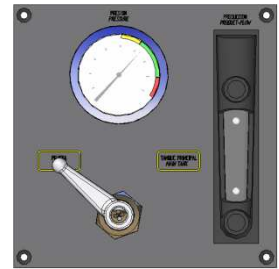

- Blue Ø 8 polyamide tube to connect the end cap plastic adaptor (10), located in the membrane vessel inlet, to the elbow located in the lower part of the flow meter (12).
- Blue Ø 8 polyamide tube to connect the three way valve “main tank” outlet (11) to the boat main tank.
- Blue Ø 8 polyamide tube from the 3way valve “MAIN TANK” outlet (11) to the boat’s main tank.
- Blue Ø 8 polyamide tube from the 3way valve “PRUEBA/TEST” outlet (11) to an accessible fresh water point, such as a tap installed in the kitchen.
- Blue Ø 6 polyamide tube between the gauge (5) and the filter adaptor located in the top of the low pressure filter vessel (6). There must not be any constrictions in this tube.

I.4. Electrical Connection.

The system is equipped with a motor for the low-pressure pump 12/24V DC 550 rated watts at 2000 rpm. It must be connected up using moisture shielded cable with a cross-section that is appropriate for the distance between the batteries and the motor. Te recommended cables are the following:

These sections are appropriate to prevent voltage losses greater than 1.6% of the rated voltage (0.2 V in 12 V DC).

- Make sure the rotation direction in the pump is correct, which is marked by the water inlet and the outlet, if it doesn’t, reverse the polarity on the motor connection.(Chapter I Page 6)

As a general rule, the electricity grid circuit should be suitably protected, taking care to oversize the connection cables to avoid voltage drops, besides an unnecessary power consumption.

ELECTRIC CONECTIONS DIAGRAM

Batteries/ Motor distance	Wire square 12V DC	24 V DC
From 0 to 5 metros	25mm ²	10 mm ²
From 6 to 12 metros	50 mm ²	16 mm ²
Circuit breaker	50Amp	25 Amp

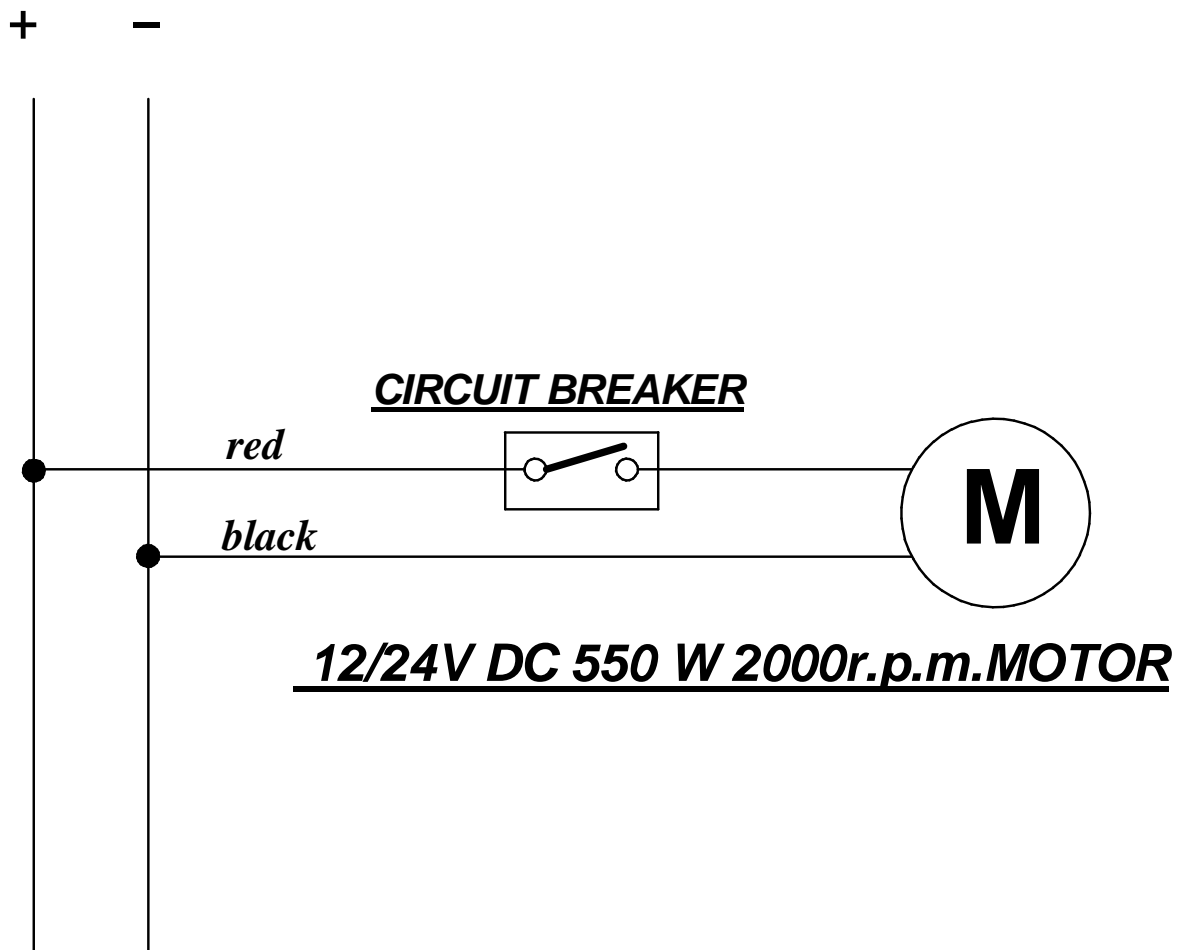

I.5. First start-up.

- Check all connections have been properly made and the voltage at the terminals is the right one.
- Check that the seacock valve (1) is open and the 3 way valve (11) is in “*PRUEBA/TEST*” position, as in the diagram, so that the first water produced can be rejected (17).
- Switch on the system and check that the rotation direction is correct.
- Make sure that the filter holders are well tighten up. Use the supplied wrench if adjustment is required.
- Make sure there is pressure in the boat fresh water circuit.
- Check that pressure in the control panel pressure gauge (5) lies between approximately 10 and 12 kg/cm², and does not exceed 15 kg/cm² under any circumstances (red zone).
- High pressure will gradually rise before stabilising at approximately 50-60 kg/cm². There may be some differences in the pressure due to possible changes in the water temperature.
- During the first few minutes, the control panel flow meter (12) will display irregular flow and air bubbles. These bubbles come from the interior of the membrane and other components of the system, causing some irregularity in the high pressure hydraulic pump cycles. They normally disappear without it being necessary purging the circuit.
- Approximately 10 minutes after the start-up, the “control tank” (17) should contain about 10 liter water produced (1 liter/minute), what determines that the production rate is correct. Stop the feed pump and put the 3 way valve (2) in **FLUSH** position, then switch on the feed pump for about 2 minutes. By that time, a significant reduction in both high and low pressure will be noticed, due to the fact that the fresh water will have reached the membranes. This operation **should be repeated twice at least**, to clean the new membranes and eliminate the membrane preservative that may have accumulated inside. During the **flushing**, the pressurized fresh water system in the boat must be “ON”, providing approximately 5 liters per minute flow, at 2 Pressure Bars.

I.6. Start-up.

- Before starting up the system, open the sea cock valve (1) to feed the unit and make sure the three-way valve (2) is in **PRODUCCION** position.
- Start the motor and check that the pressure in the control panel pressure gauge (5) lies between approximately 10 and 12 kg/cm², and does not exceed 15 kg/cm² under any circumstances (red zone).
- High pressure will gradually rise before stabilising at approximately 50-60 kg/cm². There may be some differences depending on the temperature of the water.

I.7. Turning the unit off.

Before returning the unit off, it must be cleaned to prevent a compaction of the membrane due to possible biological fouling in it, to do this proceed as follows:

- Switch off the low pressure motor pump.
- Make sure you have water on the boat's pressurized water system.
- Change the three-way valve position (2) to FLUSH and turn on the motor pump again.
- At this point the system will take fresh water from the pressurized fresh water system in the boat. The low pressure pump must be "ON", providing approximately a 5l per minute flow, at a pressure of two Bars.
- The high pressure will fall to around 20-30 kg/cm². This significant decrease in high pressure means that the seawater contained in the membranes has been cleaned out and replaced by fresh water. Changing the salinity and pH of the water in the membrane prevents the biological fouling from latching on to it for a maximum period of 90 days. For longer periods see **Chapter II Storage and Cleaning**.
- Switch off the unit and put the valves in the production position.

As a safety measure, always close the seacock valve when you turn off the system.

I.8. Maintenance of the unit.

- Regularly check the status of the sea strainer (3) and clean the mesh of dirt when needed.
- Change the 5 micron filter for a new cartridge when you see that pressure has risen between 0.5 kg/cm^2 and 1 kg/cm^2 above the one indicated on the control panel low-pressure pressure gauge at the start of operation with a new filter. This cartridge must always be replaced at the beginning of each season or at least once every three months in the event of continuous service.
- Change the active carbon cartridge at least once a year.
- When the high-pressure pressure gauge (9) exceeds 65 kg/cm^2 (with a water temperature around 18°C and 25°C), the used membrane should be replaced by a new one.
- Regularly check if the pressure in the accumulator tank (7) is 7 kg/cm^2

(An annual inspection by the Technical Support Service is recommended).

CHAPTER II

STORAGE AND CLEANING.

VERY IMPORTANT

REMEMBER THAT FOR A LONGER LIFE OF YOUR MEMBRANE, YOU MUST CLEAN THE SYSTEM WITH FRESH WATER AFTER EVERY USE .

II.1. Storage precautions.

PREVENTION OF CHEMICAL ATTACKS ON THE SYSTEM:

Do not use for storage purposes or expose the unit to hydrogen peroxide, chloramine, chloramine-T, N-chloroisocyanide, chlorine dioxide, hypochlorite, chlorine, iodine, bromine, bromide, phenolic disinfectants or any other chemical element. The use of unauthorised chemical elements or the abuse of authorised ones will invalidate any warranty.

TEMPERATURE:

Never expose the membrane to storage temperatures higher than 50°C or lower than 0°C. Never store the membrane vessel in direct sunlight. Freezing temperatures will result in mechanical damage to the system due to the expansion of air on freezing. This will cause irreversible damage to the membrane.

DRYING OUT:

Never allow the membrane to dry out. If the membrane is allowed to dry out, up to 30% of production flow will be lost. This will cause irreversible damage to the membrane. The membrane must always be kept damp.

BIOLOGICAL DIRT:

Protect the membrane from biological dirt. Up to 40% of production flow will be lost if the membrane is allowed to become dirty with biological slime. Some production, but not all, can be recovered following a thorough cleaning.

CHEMICAL DIRT:

Protect the membrane from chemical attacks or dirt. Be careful when using the system in ports that may be polluted with chemical products, oil or fuel. Chemical attack is not covered by the warranty.

STORAGE:

The inside of the membrane, which is dark and damp, is an excellent place for microorganisms to reproduce. When the membrane is used, tested or operated intermittently, it is exposed to microorganisms. Up to 50% of production flow can be lost if the membrane is not stored correctly.

II.2. Shutting down for short periods of time.

Shutting down for a short period of time means when the unit will not be used for between one day and three months. An excellent and inexpensive way to protect the system and the membrane is set out in the **Switching off the unit** section which guarantees protection against the biological fouling in the membranes. As manufacturers we recommend that **immediately after** using the system you always wash it with freshwater from the “Main Boat Tank”, sent through the carbon filter (13) in order to eliminate any rests of chlorine that may be in the water in the tank.

II.3. Shutting down for long periods of time.

(Recommended for experts only)

A long period of time or prolonged shutdown means when the unit will not be used for four months or more. In this case the unit must first be rinsed with chlorine-free fresh water, and then stored with a chemical protector. This product inhibits bacteria growth while maintaining a high circulation flow and salt rejection in the membrane.

Follow these instructions carefully:

1. Before switching off the unit: make sure you have enough water in the boat's main tank and also fill up another container with 5 litres of additional water that will be used to dissolve the preservative.
2. Switch off the low-pressure motor pump and change the position of the three-way valve to **FRESH FLUSH**. **Remember that every time a flush is performed, the pressurized water system must be “on”**. Restart the motor pump so that it suctions the water from the boat's tank through the chlorine filter (13). During this time, which lasts about 2 minutes, there will be a significant loss of high pressure before it stabilises at 20/30 kg/cm², which indicates that the unit has been cleaned. Switch off the motor pump.

1. Dissolve of 30/40 grams of chemical protector (sodium metabisulfite) with the 5 liters of water you set aside in a different container set the auxiliary valve (18) on aspiration so that it can absorb the solution.
2. Close the Seacock Valve (1), Start up the system by pressing “**PRODUCTION**”, and just before the chemical protector and water solution from the tank runs out press “**STOP**”. This means the entire circuit will contain this protecting solution.

Do not forget to shut off the seacock valve (1) as a security measure.

3. When the unit is ready to be turned on once again, the valve (1) must set to the open position and the valve (11) to the “*PRUEBA/TEST*” position so that the water produced initially is rejected. Proceed as described in **L.6FIRST START-UP (Chapter I Page 10)**.

Warning: sodium metabisulfite is a caustic product that may cause serious irritation to the skin and mucus membranes. Take due precautions before handling, do not touch it directly and always work in well-ventilated spaces.

CHAPTER III

PARTS LISTING EXPLODED VIEW OF THE ST-15/CERAMIC ECO-SYSTEMS PUMP

Eco-Sistems ST-15/CERAMIC PUMP ELEMENTS

Part Number	Breaking-Up number	Description	Quantity
44015010	1	Distributor body ST-15	1
44015020	2	Superior plate	1
44015030	3	Central frame ST-15	1
44015040	4	Control Slider base	1
44015050	5	Lower plate	1
44015060	6	External cylinder liner	1
44015070	7	Intermediate small cap ST-15 (E)	1
44015080	8	Intermediate small cap ST-15 (S)	1
44015090	9	Control slider ST-15	1
44008110	11	Central slider	1
44408130	13	Cylinder	2
44406150	15	Distributor piston	2
44008170	17	Shaft Ø25 mm	1
44008180	18	Ring shank	1
44008190	19	Shaft stopper Ø25mm	1
44008200	20	Distributor cylinder	2
44008210	21	Distributor cap	2
44008220	22	Distributor necking cap	2
44008240	24	Cylinder cap	2
44008250	25	Plunger	2
44008261	26	Distributor slider	2
44008271	27	Ceramic base ST-14	2
44405270	30	Spring stopper/gide	6
44406130	31	Spring Ø3 x 12 A4	6
43420600	35	Tube 6x4	2
43620611	36	R 1/8 elbow gas tube Ø6x4	4
43690321	37	Reduction M-3/8-H-1/4	1
43710220	38	Cap R1/4" Gas	1
43802317	39	Screw ex.DIN-931 M6x170	8
43802320	40	Screw ex.DIN-931 M6x180	6
43812060	41	Anti-lifting nut DIN- 985 M6	2
43812100	42	Anti-lifting nut DIN- 985 M10	2
43821140	43	Flat washer DIN-125 Ø14 A4	2
43822060	44	Flat washer DIN-9021 Ø6 A4	10
43822100	45	Flat washer DIN-9021 Ø10 A4	2

Part Number	Breaking-Up number	Description	Quantity
43823060	46	Grower ring Ø6 A4	14
43830606	47	Allen spike M6x6 A4	3
43850510	48	Cilindrical fastener DIN-7 A4 Ø5X10	2
43911440	49	O-ring Ø14x1.78	1
43910540	50	O-ring Ø5x2	7
43911041	51	O-ring Ø10.5x2	2
43911240	52	O-ring Ø12x2	4
43911340	53	O-ring Ø13x2	1
43911540	54	O-ring Ø15x2	2
43912235	55	O-ring Ø21.95x1.78	6
43912350	56	O-ring Ø23x2.5	2
43914050	57	O-ring Ø40x2.5	2
43914550	58	O-ring Ø45x2.5	4
43915750	59	O-ring Ø56.8x2.62	2
43916460	60	O-ring Ø64x3	2
43917560	61	O-ring Ø75x3	4
43918470	62	O-ring Ø84x3.5	1
43942000-B	65	Seal Ø20x26x5	1
43942011	66	Seal Ø20x30x8	2
43942500	67	Seal Ø25x35x10	4
43944000	68	Seal Ø40x50x6	2
43946000	69	Seal Ø60x70x6	2
43461230	71	Elbow 90° R3/8 Gas tube Ø12	2

ECO-SYSTEMS PUMP ST-15/CERAMIC

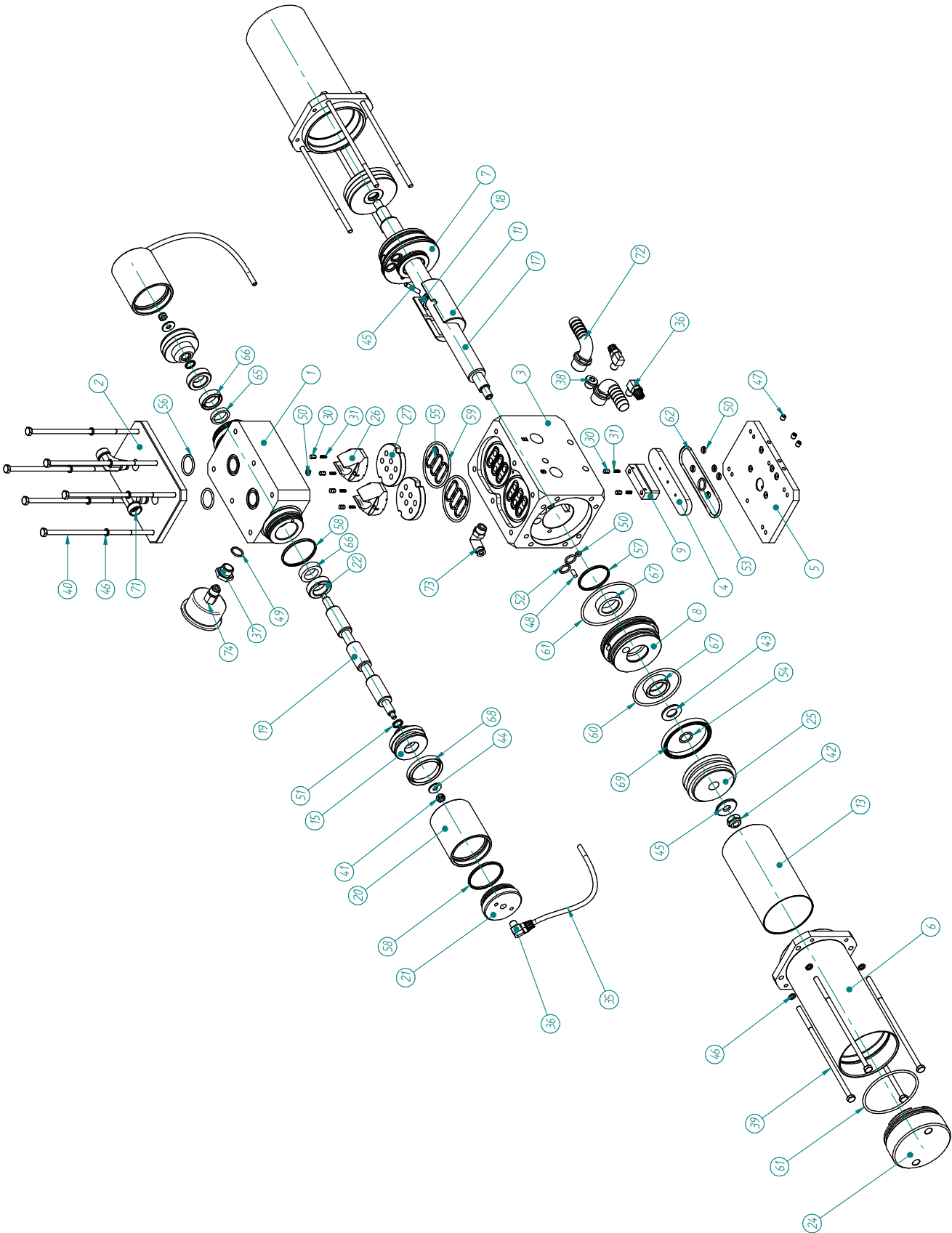

CHAPTER IV

FILTERS AND MEMBRANE REPLACEMENT

IV.1. Changing the filters.

When changing the filter cartridge make sure you have closed the seawater inlet sea cock valve before unscrewing the bowl filter that enables you to remove the old cartridge and replace it with a new one which has the same specifications: 9 ¾ long, 5 micron calibrated filter. We do not recommend another type of cartridge, it could allow unwanted particles enter the system.

Once changed, screw the bowl filter back on and re-open the seawater inlet sea cock valve. Warning: use the filter wrench to close it.

To replace the active carbon cartridge, disconnect the boat pressurized fresh water system, open a tab to not leave any residual pressure in the circuit, and replace the active carbon cartridge. Connect the boat pressurized fresh water system again.

IV.2. Membrane Replacement.

Follow these instructions to change the membrane, see diagram (Chapter IV Page 3)

- Before handling the unit, make sure there is no pressure in the circuit. If the pressure gauge indicates there is some, wait until it disappears.
- Dismantle the high pressure hoses, taking care to have two wrenches so as not to loosen the fittings of the end caps (7) located on the vessel (1).
- Remove the end caps (7) to get access to the membrane (2), unscrewing them with the help of a special pivot wrench.
- Once the membrane have been removed, clean the inside of the vessel with chlorine-free water. This will remove dirt, and the water will act as a lubricant for inserting the new membrane.
- Take the new membrane out of its packaging (the packaging is usually an airtight plastic bag).
- Check that the membrane seal have no malfunctions, damages or a excessive lack between it and the membrane. It has to be placed with its lips against the water flow direction (see drawing). Lubricate the seal with water before being placed in the vessel.

- The seal is located only in one side of the membrane, the outlet side. There is no seal in the inlet side.
- Check that the membrane permeation tube fits properly into the O-rings inside the sealing caps (7).
- Place the membrane and screw the end caps previously removed, with the pivot wrench.
- Reassemble the vessel on its supports.
- Reconnect the high pressure hoses, making sure the fitting nuts are well tight. Connect the fresh water outlet.

NOTE:

De location of the seal on the membrane, is different than in the 2540 Standard model, it is placed on the side marked as (OUTLET) with its lips against the water flow direction (FLOW).

Before restarting the unit, make sure the valve (11) (see drawing in Chapter I, Page 1) is in the “*PRUEBA/TEST*” position and proceed as indicated in Chapter I section 5 **FIRST START-UP** following all the steps set out in that section in detail.

WARNING.- The membrane may have air inside and it needs a few minutes to be completely taken out.

